

RIGHT HAND PORT ORIENTATION

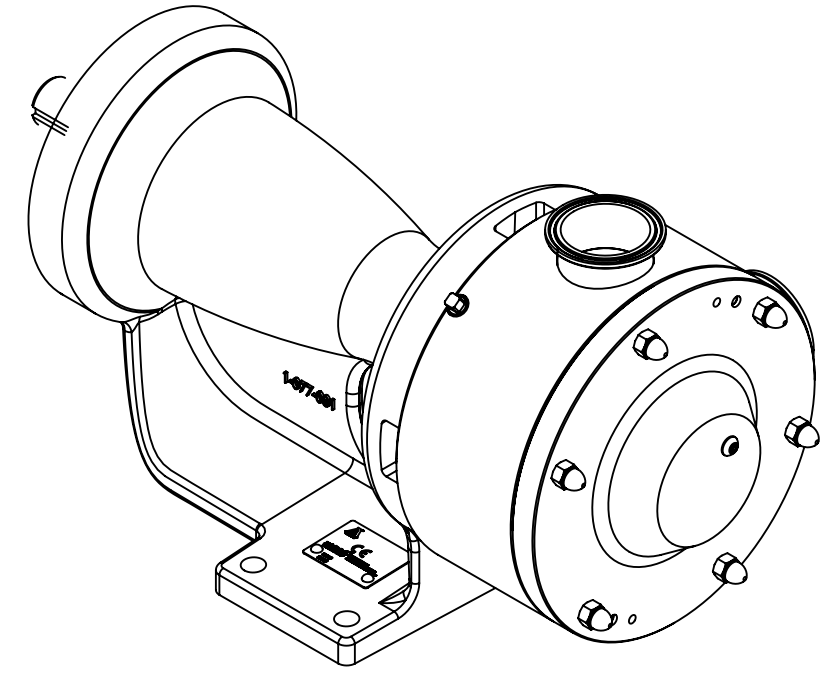

LEFT HAND PORT ORIENTATION

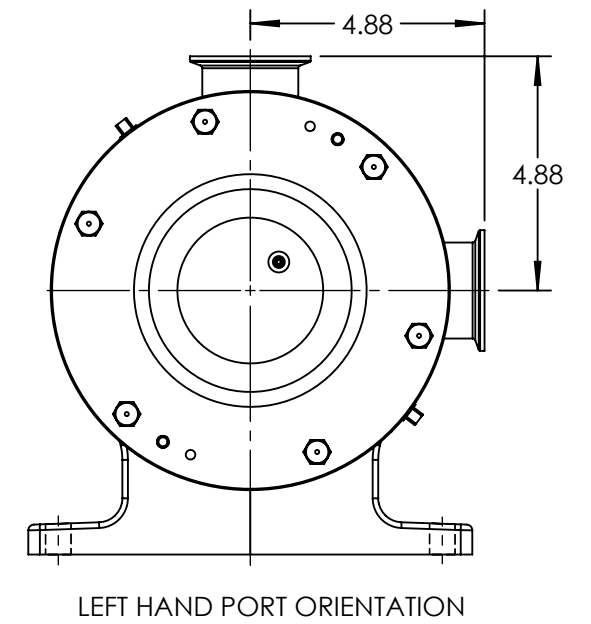
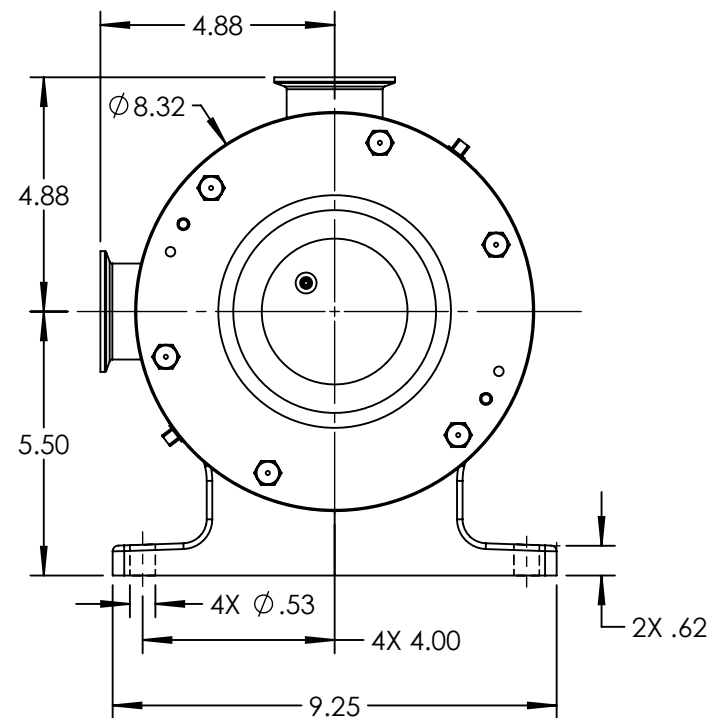
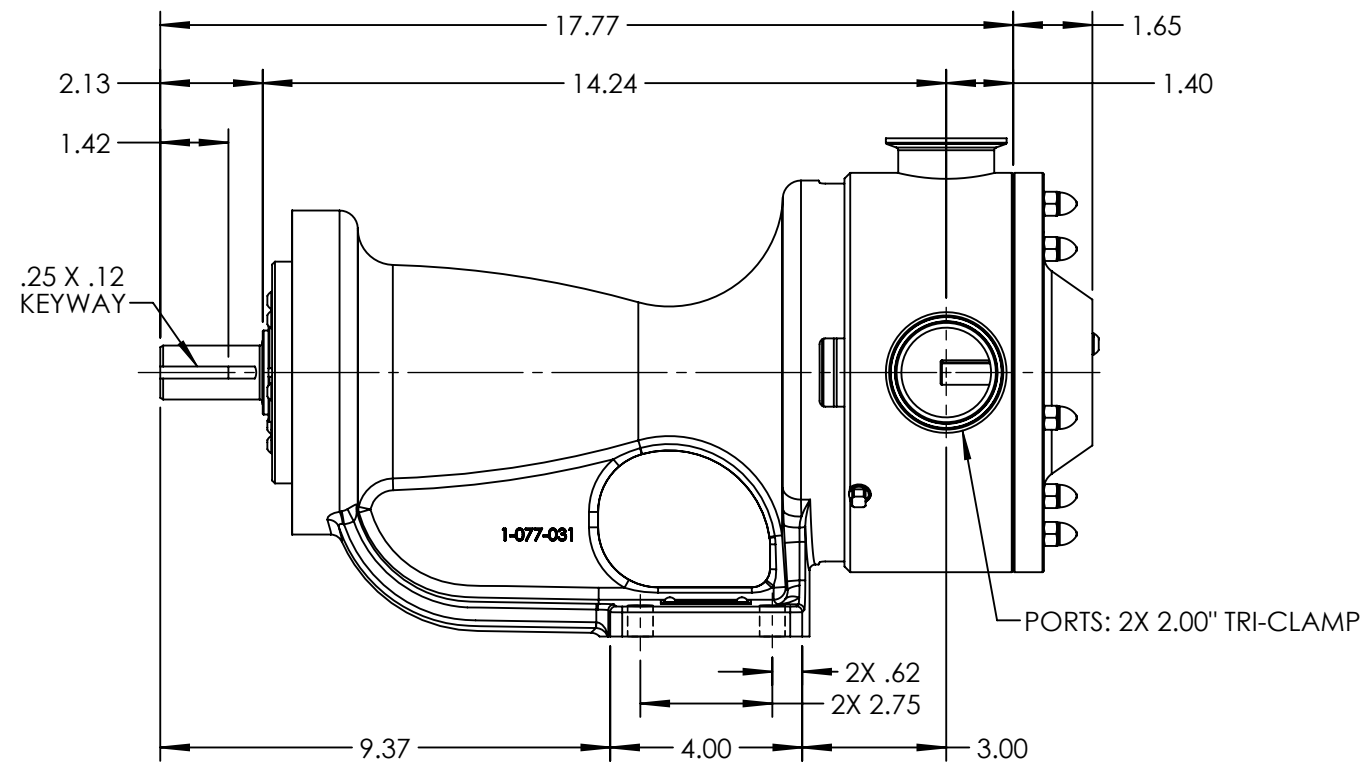

LEFT HAND PORT ORIENTATION

NOTES:
1. ALL DIMENSIONS ARE FOR REFERENCE ONLY.

STANDARD MODELS: K4157B, K157B

STATE	Released	05/21/2014	DIMENSIONS ARE IN INCHES
DRAWN	tdutcher	5/9/2014	PROJECT: D923
CHECKED	JAD	05/21/2014	WAS:



VIKING PUMP, INC.
A Unit of IDEX Corporation
Cedar Falls, IA 50613
U.S.A.

THIS DRAWING IS THE PROPERTY OF VIKING PUMP, INC. AND IS PROPRIETARY IN GENERAL AND DETAIL. IT SHALL NOT BE COPIED OR ITS CONTENTS REVEALED TO OUTSIDE PARTIES WITHOUT THE WRITTEN CONSENT OF VIKING PUMP, INC.

3D

DWG. NO.
KV-2462

SHEET 1 OF 1

REV. A.0

05/21/2014