

HORIZONTAL PORT ORIENTATION

VERTICAL PORT ORIENTATION

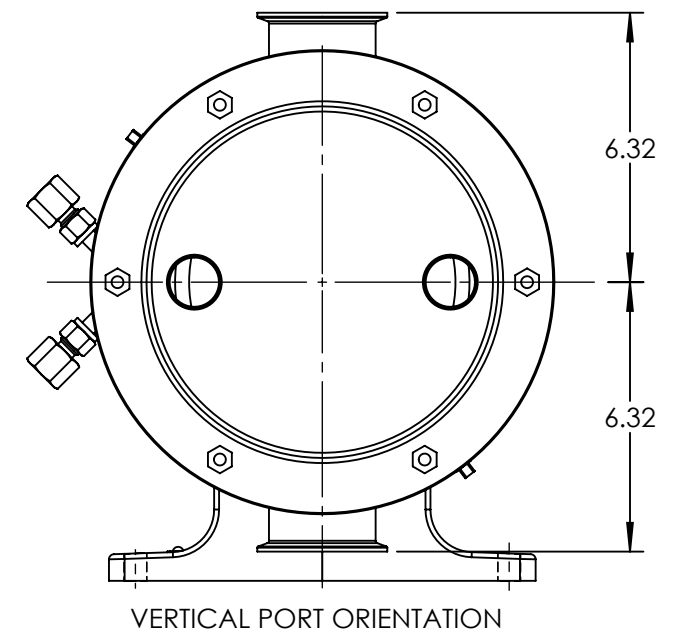
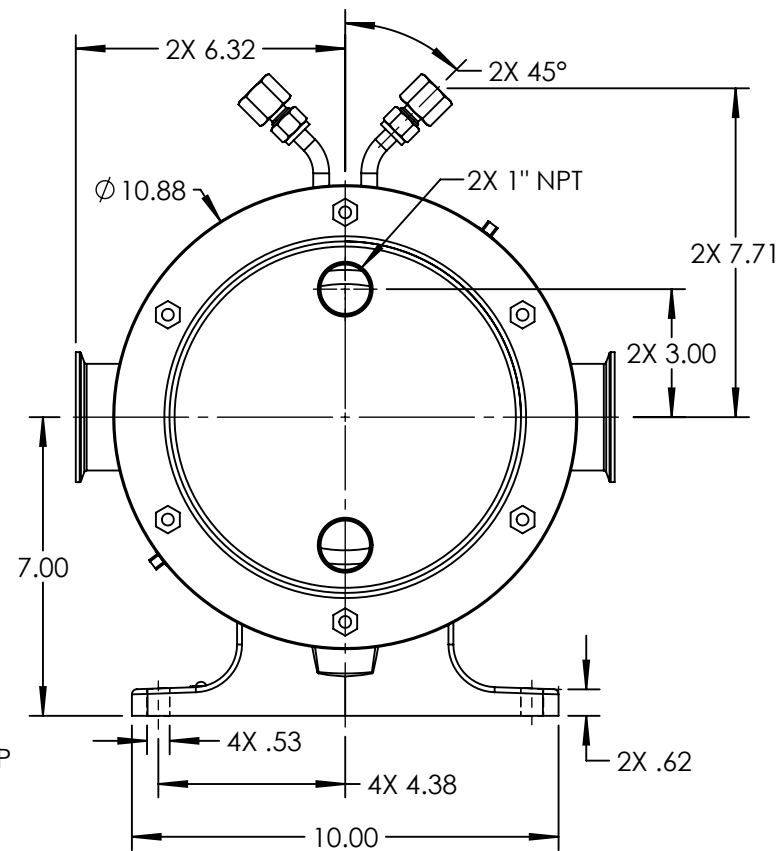
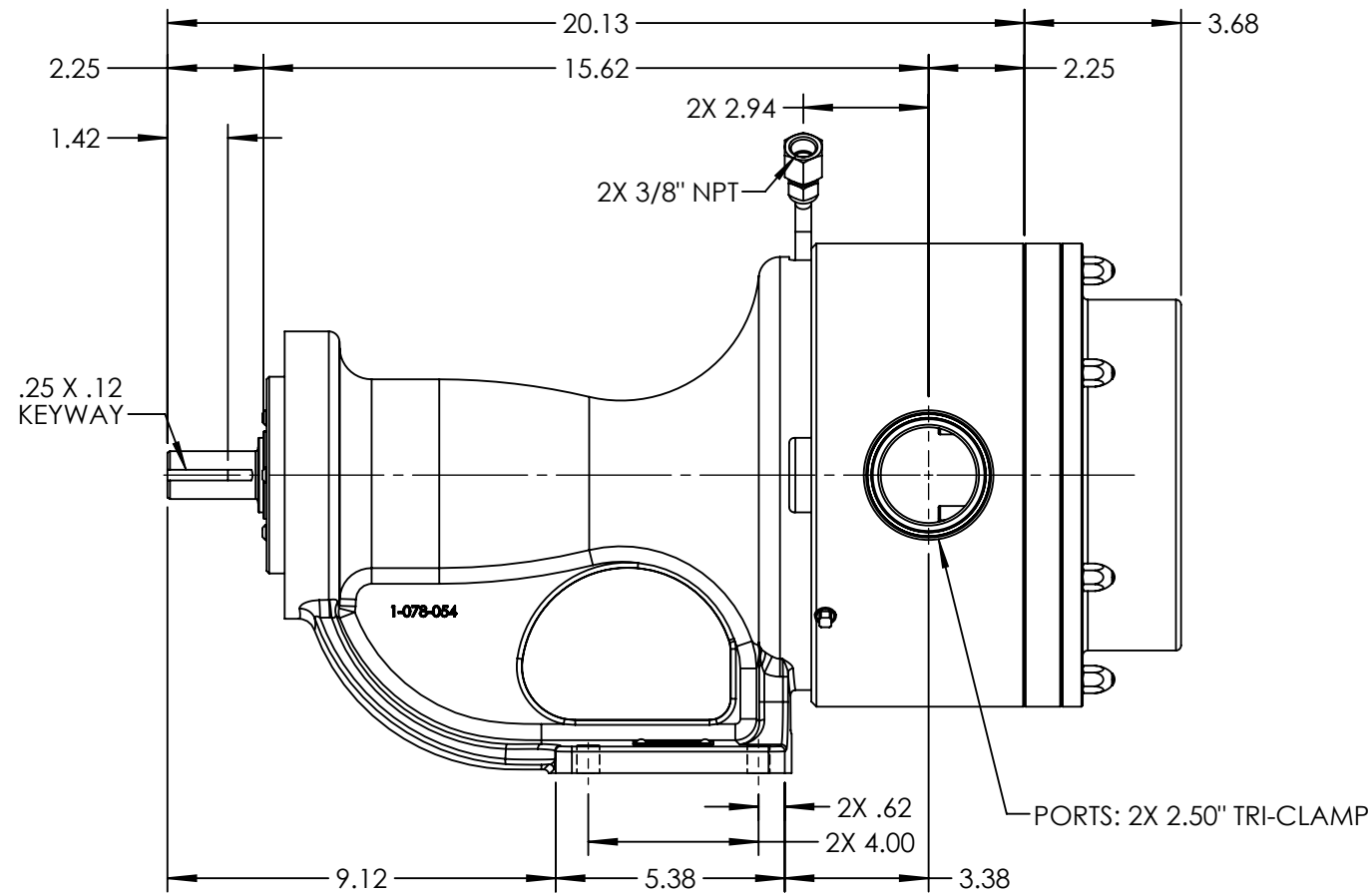

VERTICAL PORT ORIENTATION

NOTES:  
1. ALL DIMENSIONS ARE FOR REFERENCE ONLY.

STANDARD MODELS: LQ4257B, LQ257B

STATE	Released	07/29/2014	DIMENSIONS ARE IN INCHES
DRAWN	tdutcher	7/23/2014	PROJECT: D923
CHECKED	JAD	07/29/2014	WAS:



VIKING PUMP, INC.  
A Unit of IDEX Corporation  
Cedar Falls, IA 50613  
U.S.A.

THIS DRAWING IS THE PROPERTY OF VIKING PUMP, INC. AND IS PROPRIETARY IN GENERAL AND DETAIL. IT SHALL NOT BE COPIED OR ITS CONTENTS REVEALED TO OUTSIDE PARTIES WITHOUT THE WRITTEN CONSENT OF VIKING PUMP, INC.

3D

DWG. NO.  
LV-4251

SHEET 1 OF 1 REV. A.0

07/29/2014