

MOTOR FRAMES:
324TC-326TC

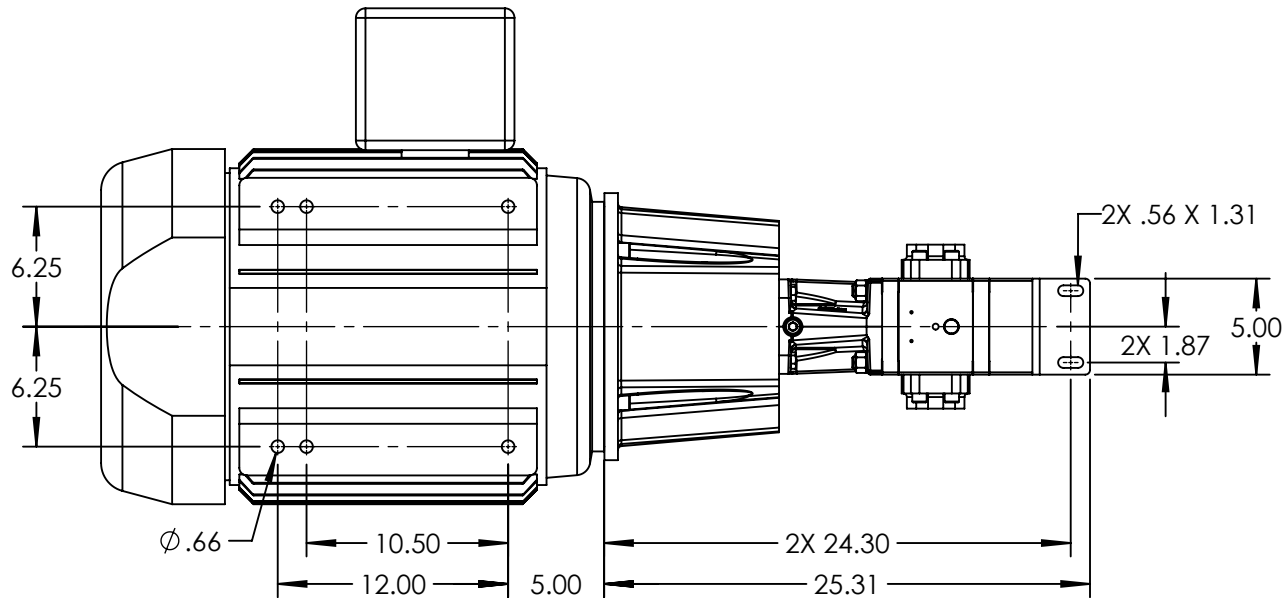
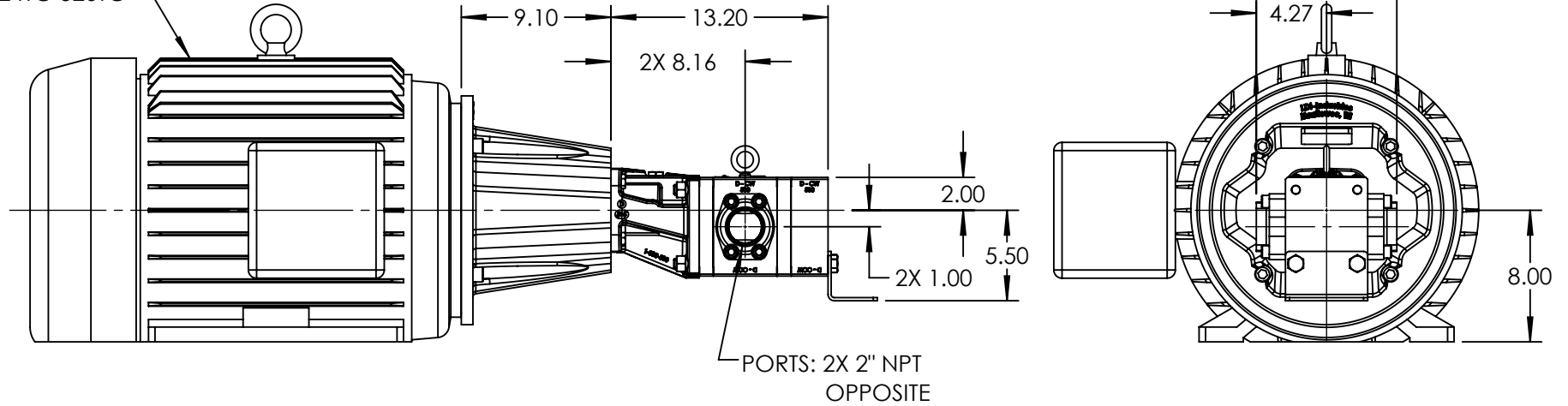

MODELS: GL-41018-G0A-M, GL-41018-G1A-M, GL-41018-G0B-M, GL-41018-G1B-M,
GP-41018-G0O-M, GP-41018-G1O-M

NOTES:
1. ALL DIMENSIONS ARE FOR REFERENCE ONLY.

STATE	Released	04/29/2019
DRAWN	AMeek	10/17/2018
CHECKED	JDP	04/29/2019

DIMENSIONS ARE IN INCHES
PROJECT: E299
WAS:



VIKING PUMP, INC.
A Unit of IDEX Corporation
Cedar Falls, IA 50613
U.S.A.

THIS DRAWING IS THE PROPERTY OF
VIKING PUMP, INC. AND IS PROPRIETARY
IN GENERAL AND DETAIL. IT SHALL NOT BE
COPIED OR ITS CONTENTS REVEALED TO
OUTSIDE PARTIES WITHOUT THE WRITTEN
CONSENT OF VIKING PUMP, INC.

3D

DWG. NO. SHEET 1 OF 1
GPV-1018-020-U

REV. A.1
04/29/2019