

VIEW A-A

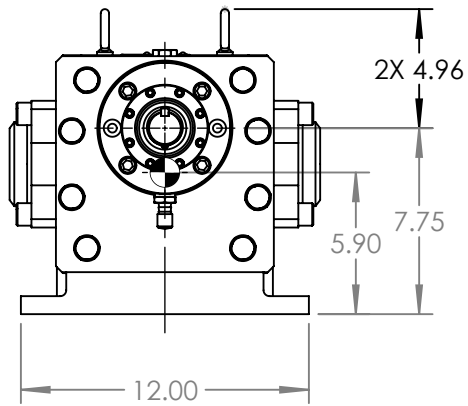

KEY .31 X .31 X 2.00

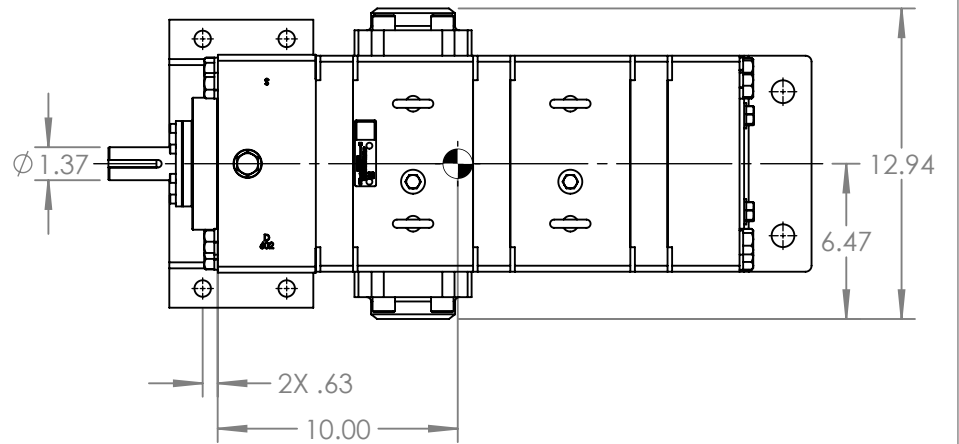
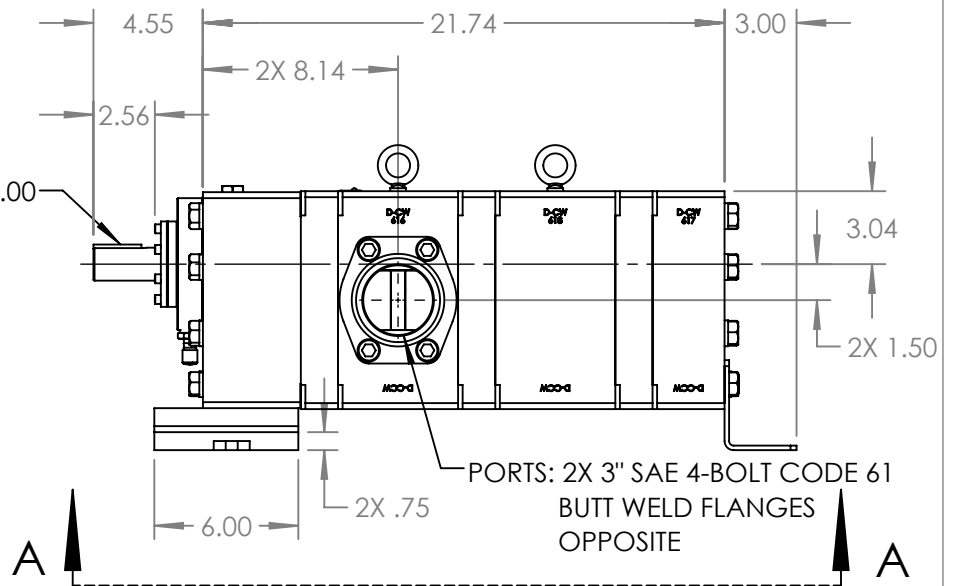

NOTES:

1. ALL DIMENSIONS ARE FOR REFERENCE ONLY.

MODELS: GB-41445-K00, GB-41445-K10, GB-41445-R00, GB-41445-R10

STATE	Released	07/21/2020
DRAWN	bmanernach	6/29/2020
CHECKED	GDJ	07/20/2020

DIMENSIONS ARE IN INCHES
PROJECT: E302
WAS: EX-E302-23



VIKING PUMP, INC.
A Unit of IDEX Corporation
Cedar Falls, IA 50613
U.S.A.

THIS DRAWING IS THE PROPERTY OF VIKING PUMP, INC. AND IS PROPRIETARY IN GENERAL AND DETAIL. IT SHALL NOT BE COPIED OR ITS CONTENTS REVEALED TO OUTSIDE PARTIES WITHOUT THE WRITTEN CONSENT OF VIKING PUMP, INC.

3D

DWG. NO. GPV-1445-019-U
SHEET 1 OF 1

REV. A.0
07/21/2020